

IB and IS series

Sealed pushbutton switches - bushing Ø 12 mm - momentary

Distinctive features and specifications

UG1410-A-R1



- Snap-in and threaded bushing models
- Compact, light in weight
 - Behind-panel depth of 13 mm (.512) only
 - 50 % reduction in weight compared to metallic models
- Tactile feedback
- Sealed to IP67 (IS series) or IP54 (IB series)

ENVIRONMENTAL SPECIFICATIONS

- Front panel sealing according to IEC 60529 : IP67 (IS) or IP54 (IB)
- Shock resistance : 100 g according to IEC 512-4, test 6c
- Vibration resistance : 10-500 Hz - 10 g according to IEC 512-4, test 6d
- Salt spray : IEC 512-6, test 11f
- Operating temperature : -40°C to +85°C

MATERIALS

- Case : thermoplastic UL94-V0
- Actuator : polyamide 6/6
- Bushing/bezel : polyamide 6/6
- Contacts : silver, gold plated
- Terminal seal : epoxy

ELECTRICAL SPECIFICATIONS

- Max. current/voltage rating with resistive load :
400mA 32VAC - 100mA 48VDC
- Initial contact resistance : 50 mΩ max.
- Insulation resistance : 1 GΩ min. at 500VDC
- Dielectric strength : 1.000 Vrms
- Electrical life at full load : 500.000 cycles

AGENCY APPROVAL



2A 125VAC/250VAC
File E83438

Availability : consult factory for details of approved models.

Marking : to order switches marked UL, complete appropriate box of ordering format.

GENERAL SPECIFICATIONS

- Panel thickness :
 - IB series : 0,8 mm (.031) min. - 1,8 mm (.071) max.
 - IS series : 1,5 mm (.059) min. - 4 mm (.157) max.
- Total travel : 1,7 mm (.066) +/- 0,3 mm
- Typical operating force : 4N +/- 3N
- Low level or mechanical life : 1.000.000 cycles
- Torque (applied to nut) : 1 Nm max. with metal nut U166
1,5 Nm max. with plastic nut U4248
- Soldering : 300°C max. for 3 seconds

Panel mounting : see next pages.

*Example of custom switch:
see end of the series.*

The company reserves the right to change specifications without notice.

IB and IS series

Sealed pushbutton switches - bushing Ø 12 mm - momentary

Overview

MODEL
STRUCTURE

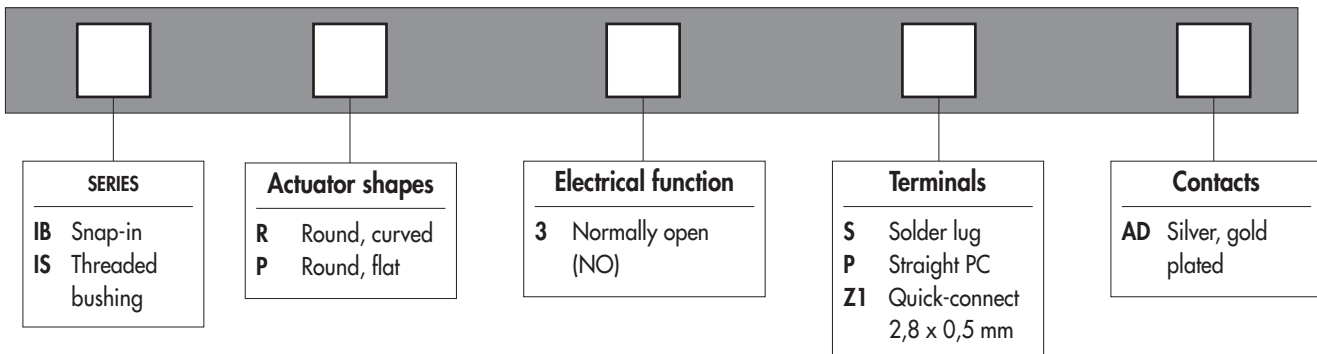

OPTIONS

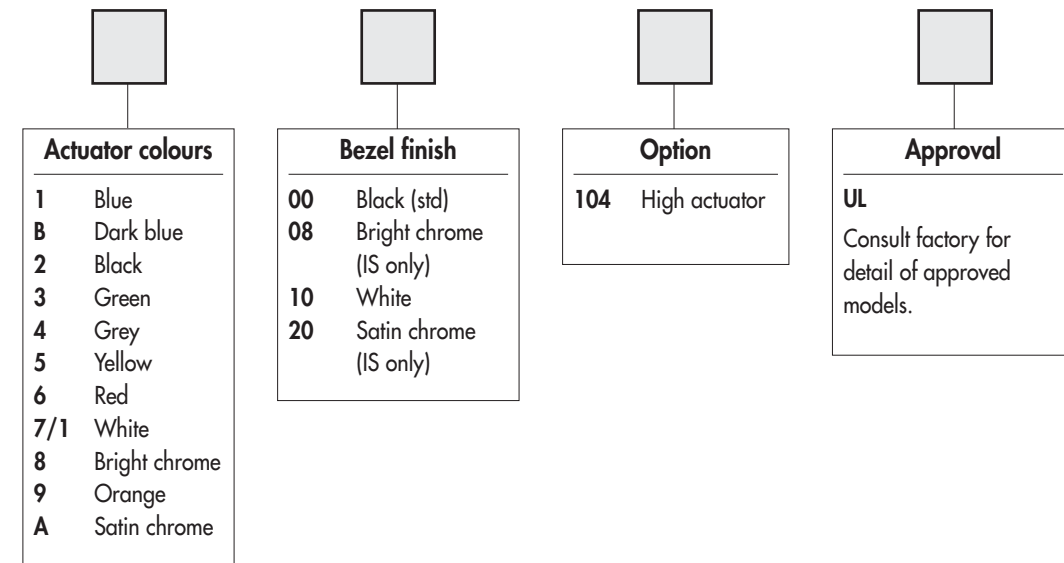

ABOUT THIS SERIES

On the following pages, you will find successively :

- model structure of switches and options in the same order as in above chart

Dimensions : first dimensions are in mm while inches are shown as bracketed numbers.



NOTICE : please note that not all combinations of above numbers are available. Refer to the following pages for further information.



A sealing boot is available to protect the switches against frost and sand. It is presented after the IA series and in section H.



Mounting accessories : Standard hardware supplied : 1 flat seal (IB series)
1 metal hex nut 14 mm (.551) across flats, part number U166, and 1 flat seal (IS series).
Plastic nut 17 mm (.669) across flats, thickness 4 mm (.157) available on request. Part number U4248.



Packaging unit : 50 pieces

IB and IS series

Sealed pushbutton switches - bushing Ø 12 mm - momentary

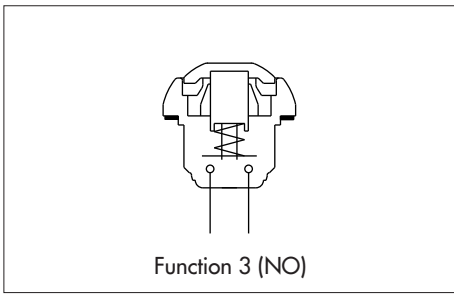

- Ten actuator colours
- Curved or flat actuator
- Antirotation bushing

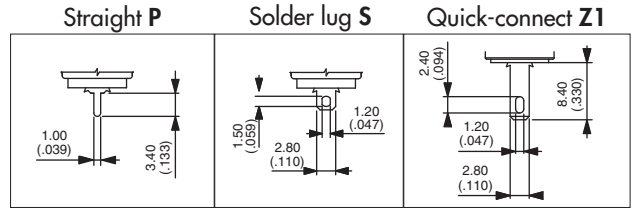

MODEL STRUCTURE



Actuator marking available on IBP and ISP models (symbol 10 mm max.). On request.

Snap-in mounting - solder lug terminals

→ Flat

Panel thickness : 0,8 mm to 1,8 mm



- Curved actuator
IBR3SAD Normally open
- Flat actuator
IBP3SAD Normally open

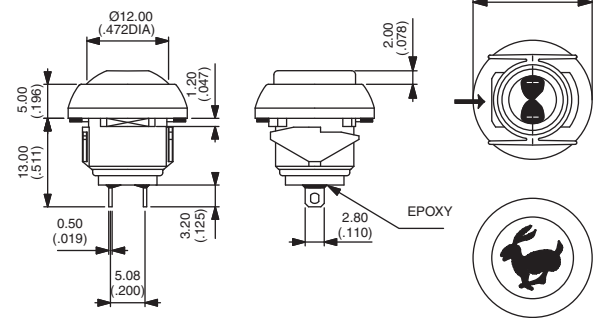

Also available with straight PC : **IB•3PAD** or quick-connect terminals : **IB•3Z1AD**

Mounting by threaded bushing - solder lug terminals

→ Flat

Panel thickness : 1,5 mm to 4 mm



- Curved actuator
ISR3SAD Normally open
- Flat actuator
ISP3SAD Normally open

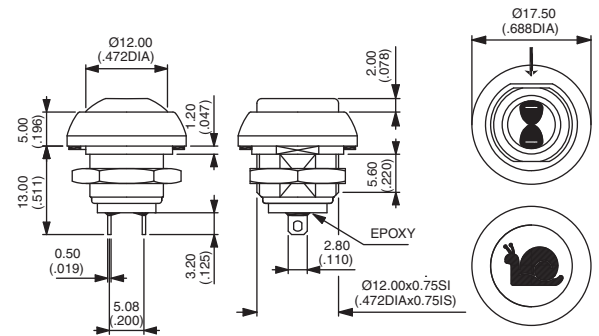

Also available with straight PC : **IS•3PAD** or quick-connect terminals : **IS•3Z1AD**

ACTUATOR COLOURS

Actuator marking available on IBP and ISP models (symbol 10 mm max.). On request.

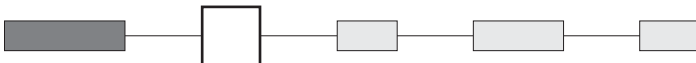

- 1 : blue - B : dark blue - 2 : black - 3 : green - 4 : grey - 5 : yellow - 6 : red - 7/1 : white - 8 : bright chrome
 9 : orange - A : satin chrome

BUSHING AND BEZEL FINISH



- 00 : Black (standard)
 08 : Bright chrome (IS series only)
 10 : White
 20 : Satin chrome (IS series only)

IB and IS series

Sealed pushbutton switches - bushing \varnothing 12 mm - momentary

ACTUATOR OPTION

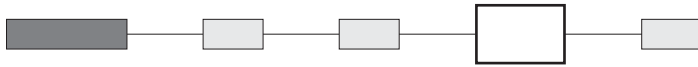

104 : High actuator

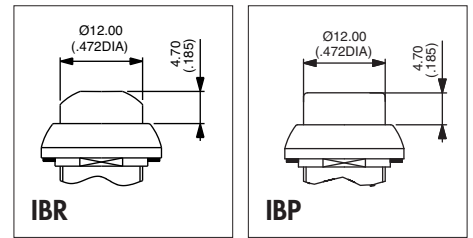

APPROVAL

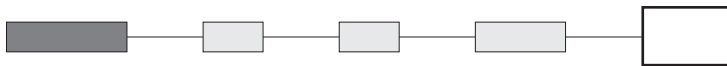

UL

Availability : consult factory for details of approved models.

Marking : to order switches marked UL, complete above box with "UL".

IB SERIES MOUNTING

Panel cut-out

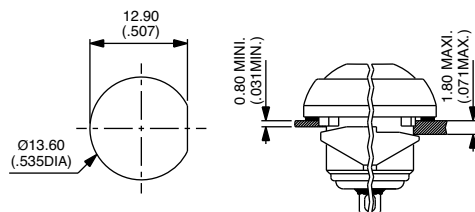

Matrix mounting

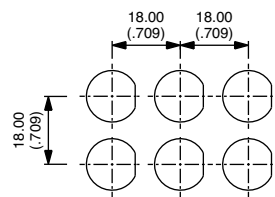

IS SERIES MOUNTING

Panel cut-out

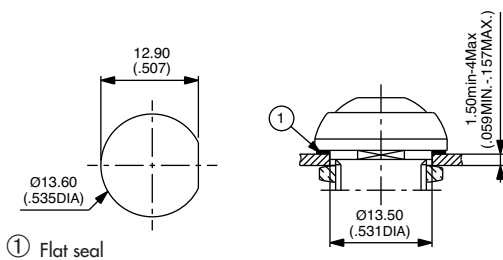

Matrix mounting

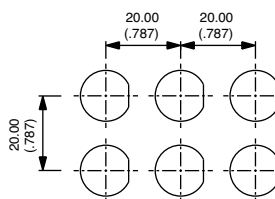

Example of custom switch



ISR3FADB22X1248-01

- Painted bushing and actuator, soft feel
- Flying leads (55 mm) + connector
- Overmolded rear part